

Pfaff 418
Subclass

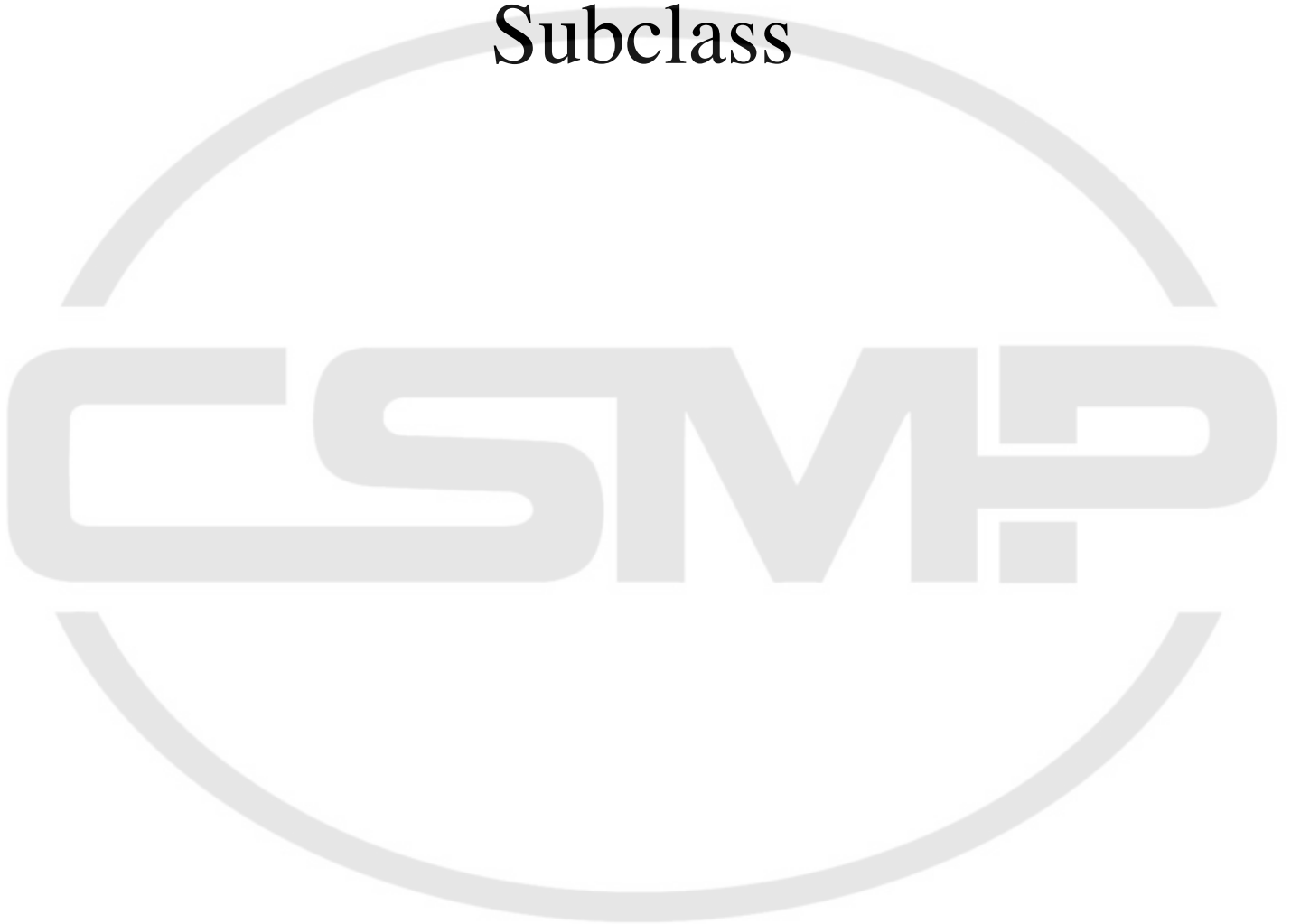

418

Unterklassen-Ausstattung

Subclass parts

Composition des sous-classes

Composición de las subclases

CSMP

Table of subclasses
Table des sous-classes
Tabla de subclases **PFAFF 418**

Unterklasse Subclass Sous-classe Subclase	-6/01 (-900/..)	-45/11-915/05 (-900/..)	-45/11-915/05 (-900/..)	-45/12-915/04	-45/12-915/05 (-900/..)
Arbeitsgang Operation Opération Operación	Für allgemeine Näharbeiten. Standardform des Teilesatzes. For ordinary sewing operations. Standard parts set. Travaux d'utilité courante. Jeu de pièces standard. Para trabajos de costura en general. Juego de piezas estándard.				
Ausführung Model Version Tipo de máquina	A; B	A; B	A; B	B	B
Nadelabstand in mm Needle gauge in mm Ecartement des aiguilles en mm Distancia entre agujas en mm		4,5	6,0	10,0	4,5
Überstichbreite in mm Stitch width in mm Jetée de l'aiguille en mm Anchura del zigzag en mm	10,0				
Nadelstange Needle bar Barre à aiguille Barra de aguja	91-168 019-91	91-167 537-91	91-167 537-91	91-167 637-91	91-167 537-91
Stoffschieber ⁴ Feed dog Griffe Transportador inferior	91-047 559-04	91-047 570-04	91-047 678-04	91-047 649-04	91-047 570-04
Stichplatte ⁴ Needle plate Plaque à aiguille Placa de aguja	91-058 089-24	91-058 253-04 ^{10/2}	91-058 254-04	91-058 857-04	91-058 253-04 ^{10/2}
Stichplatteneinsatz Needle plate insert Applique de plaque Aplicue de la placa de aguja		91-026 900-14 ^{20/2}	91-026 900-14 ^{20/2}	91-058 636-04 x 4,0 ^{65/8}	91-026 904-14 ^{21/2}
Rollfuß ⁴ Roller presser Pied à roulette Pie rodante		91-057 012-93 ^{10/2}	91-057 012-93 ^{10/2}	91-057 007-93	91-057 012-93 ^{10/2}
Nähfuß ⁴ Presser foot Pied presseur Pie prensatelas	91-055 106-23 ^{11/2}				
Kordellührung Cording guide Guide-cordonnet Guia para cordoncillo				91-129 955-25	
Führungsbügel Guide wire Passe-fil Guia de alambre				91-057 193-04	
Bandrollenträger Tape reel bracket Plateau dérouleur Portarrollos				91-129 730-70/895	

Table des sous-classes
 Tabla de subclases PFAFF 418



Unterklasse Subclass Sous-classe Subclase	-45/12-915/05 (-900/..)	-45/12-915/05	-45/22-915/23 (-900/..)	-47/11 (-900/..)	-47/12-944/01 (-900/..)	-49/01 (-900/..)
Arbeitsgang Operation Opération Operación						
Ausführung Model Version Tipo de máquina	B	B/CN	A; B	B	C	A; B
Nadelabstand in mm Needle gauge in mm Ecartement des aiguilles en mm Distancia entre agujas en mm	6,0	6,0	8,0			
Überstichbreite in mm Stitch width in mm Jetée de l'aiguille en mm Anchura del zigzag en mm				10,0	8,0	10,0
Nadelstange Needle bar Barre à aiguille Barra de aguja	91-167 537-91	91-167 537-91	91-167 523-91	91-167 845-91	91-167 845-91	91-168 019-91
Stoffschieber [4] Feed dog Griffe Transportador inferior	91-047 678-04	91-047 678-04	91-047 642-04	91-059 565-04	91-059 640-04	91-047 649-04
Stichplatte [4] Needle plate Plaque à aiguille Placa de aguja	91-058 254-04	91-058 844-04	91-058 673-04	91-058 832-04	91-158 430-24	91-058 380-04
Stichplatteneinsatz Needle plate insert Applique de plaque Aplic de la placa de aguja	91-026 904-14 [21/2]	91-058 636-04 x 4,0 [95/8]	91-058 674-05			91-158 185-15
Stichlockerungsfinger Thread loosening finger Doigt tire-fil Dedo para dar más hilo a la puntada					91-156 052-91	
Rollfuß [4] Roller presser Pied à roulette Pie rodante	91-057 012-93 [10/2]	91-057 007-93	91-057 006-93		91-157 928-93	
Nähfuß [4] Presser foot Pied presseur Pie prensateelas				91-057 408-93		91-055 530-03
Lineal Edge guide Guide-droit Guía recta				91-056 063-21	91-156 186-15	
Kordelführung Cording guide Guide-cordonnet Guía para cordoncillo		91-129 955-25	91-129 955-25			
Führungsbügel Guide wire Passe-fil Guía de alambre		91-057 193-04				
Bandrollenträger Tape reel bracket Plateau dérouleur Portarrollos		91-129 730-70/895				

□ siehe Erläuterungen Register [A] [99]
 see explanations in section [A] [99]
 voir légende registre [A] [99]
 ver explicaciones del registro [A] [99]

Table of subclasses
Table des sous-classes
Tabla de subclases PFAFF 418

Unterklasse Subclass Sous-classe Subclase	-49/01-915/02	-55/10-915/05 (-900/..)	-61/01-915/04	-61/02 (-900/..)	-61/08-915/02
Arbeitsgang Operation Opération Operación					
Ausführung Model Version Tipo de máquina	A; B	A; B	B	B	A; B
Nadelabstand in mm Needle gauge in mm Ecartement des aiguilles en mm Distancia entre agujas en mm	10,0	4,5	10,0		8,0
Überstichbreite in mm Stitch width in mm Jetée de l'aiguille en mm Anchura del zigzag en mm				10,0	
Nadelstange Needle bar Barre à aiguille Barra de aguja	91-167 078-91	91-167 537-91	91-167 637-91	91-168 019-91	91-167 078-91
Stoffschieber ⁴ Feed dog Griffe Transportador inferior	91-047 649-04	91-047 570-04	91-047 559-04	91-047 559-04	91-047 647-04
Stichplatte ⁴ Needle plate Plaque à aiguille Placa de aguja	91-058 380-04	91-058 086-24 ^{10/2}	91-058 089-24	91-058 089-24	91-058 379-04
Stichplatteneinsatz Needle plate insert Applique de plaque Aplic de la placa de aguja	91-158 185-15				91-048 103-05
Rollfuß ⁴ Roller presser Pied à roulette Pie rodante		91-057 012-93 ^{10/2}			
Nähfuß ⁴ Presser foot Pied presseur Pie prensateñas	91-055 530-03		91-154 023-03 ^{15/1} ¹⁵ = 12,0 - 15,0 mm	91-055 106-23 ^{13/2}	91-055 550-93 ^{10/2} ^{15/1} ¹⁵ = 9,0 - 14,0 mm 91-154 398-05 ^{15/1} ²⁸ ¹⁵ = 5,0 - 10,0 mm 91-154 399-05 ^{15/1} ²⁸ ¹⁵ = 5,0 - 10,0 mm
Träger Bracket Support Soporte				91-040 862-90	
Kopfplatte Face plate Plaque frontale Placa frontal				91-168 461-71/893	
Zwischenplatte Distance plate Plaque intermédiaire Placa intermedia				91-168 049-75/893	
Bandführung Tape guide Guide-ruban Guiacintas				91-043 408-23 ⁵	
Führungsbügel Guide wire Passe-fil Guía de alambre			91-055 555-05		91-055 555-05
Bandtrommel Tape reel Tambour-dérouleur Tambor-portacintas			91-056 758-70/895 91-008 026-05 91-084 338-05	91-056 758-70/895	91-056 758-70/895
Bandrollenträger Tape reel bracket Plateau dérouleur Portarrollos					91-043 938-70/895

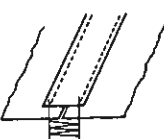
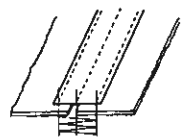
Table des sous-classes
 Tabla de subclases PFAFF 418

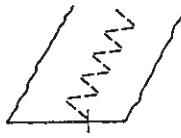
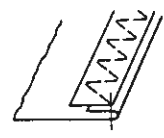
Unterklasse Subclass Sous-classe Subclase	-61/08-915/02	-61/08-915/03	-72/21 (-900/..)	-716/04-6/01 (-900/..)	-716/04-82/12 (-900/..)
Arbeitsgang Operation Opération Operación					
Ausführung Model Version Tipo de máquina	A; B	A; B	A; B	AN 2,5; BN 2,5	AN 2,5; BN 2,5
Nadelabstand in mm Needle gauge in mm Écartement des aiguilles en mm Distancia entre agujas en mm	10,0	10,0			
Überstichbreite in mm Stitch width in mm Jetée de l'aiguille en mm Anchura del zigzag en mm			8,0	8,0	8,0
Nadelstange Needle bar Barre à aiguille Barra de aguja	91-167 078-91	91-168 846-91	91-168 019-91	91-168 019-91	91-168 019-91
Stoffschieber [4] Feed dog Griffe Transportador inferior	91-047 649-04	91-047 649-04	91-047 642-04	91-047 643-04	91-047 643-04
Stichplatte [4] Needle plate Plaque à aiguille Placa de aguja	91-058 380-04	91-058 380-04	91-058 374-03	91-058 207-24	91-058 207-24
Stichplatteneinsatz Needle plate insert Applique de plaque Apilique de la placa de aguja	91-048 103-05	91-048 103-05			
Nähfuß [4] Presser foot Pied presseur Pie prensatelas	91-055 550-93 [10/2] [15/1] [15] = 9,0 - 14,0 mm 91-154 398-05 [15/1] [28] [15] = 5,0 - 10,0 mm 91-154 399-05 [15/1] [28] [15] = 5,0 - 10,0 mm	91-055 818-03 [10/2] [15/1] [15] = 12,0 - 15,0 mm	91-055 530-03	91-055 106-23 [11/2]	91-055 366-93 [11/2]
Apparat [5] Attachment Appareil Aparato					91-050 716-93
Träger Bracket Support Soporte					91-156 634-90
Bandführung Tape guide Guide-ruban Gulacintas		*	91-053 228-21		
Führungsbügel Guide wire Passe-fil Guía de alambre	91-055 555-05	91-055 555-05			
Bandtrommel Tape reel Tambour-dérouleur Tambor-portacintas	91-056 758-70/895	91-056 758-70/895	91-041 644-70/895		91-056 758-70/895
Bandrollenträger Tape reel bracket Plateau dérouleur Portarrollos	91-043 938-70/895	91-043 938-70/895			
Platte und Feder Plate and spring Plaque et ressort Placa y muelle					91-170 363-15 91-170 364-15

☐ siehe Erläuterungen Register [A] - [92]
 see explanations in section [A] - [92]
 voir légende registre [A] - [92]
 ver explicaciones del registro [A] - [92]

Table of subclasses
Table des sous-classes
Tabla de subclases

PFAFF 418









Unterklasse Subclass Sous-classe Subclase	-716/06-6/01 (-900/..)	-716/06-6/01 -915/05 (-900/..)	-716/06-17/82 (-900/..)	-716/06-17/91 (-900/..)	-716/06-39/82 (-900/..)	-716/06-61/04 (-900/..)
Arbeitsgang Operation Opération Operación						
Ausführung Model Version Tipo de máquina	AN 2,5; BN 2,5	AN 2,5; BN 2,5	AN 2,5; BN 2,5	AN 2,5; BN 2,5	AN 2,5; BN 2,5	AN 2,5; BN 2,5
Nadelabstand in mm Needle gauge in mm Ecartement des aiguilles en mm Distancia entre agujas en mm		6,0				
Übersichtsbreite in mm Stitch width in mm Jetée de l'aiguille en mm Anchura del zigzag en mm	10,0	10,0	10,0	8,0	10,0	10,0
Nadelstange Needle bar Barre à aiguille Barra de aguja	91-168 019-91	91-167 809-91	91-168 019-91	91-168 019-91	91-168 019-91	91-168 019-91
Stoffschieber [4] Feed dog Griffe Transportador inferior	91-047 645-04	91-047 645-04	91-047 827-04	91-047 802-04	91-047 827-04	91-047 645-04
Stichplatte [4] Needle plate Plaque à aiguille Placa de aguja	91-058 208-24	91-058 208-24	91-058 442-24	91-058 386-24	91-058 442-24	91-058 208-24
Nähfuß [4] Presser foot Pied presseur Pie prensatelas	91-055 106-23	91-055 726-03	91-055 708-93	91-055 544-23	91-055 708-93	91-055 524-93
Lineal Edge guide Guide-droit Guía recta		91-056 104-91				91-050 648-25
Apparat [5] Attachment Appareil Aparato			91-056 106-23	91-050 959-93	91-056 075-23	
Haltewinkel Bracket Equerre de retenue Soporte angular				91-025 559-25		91-025 559-25
Träger Bracket Support Soporte			91-056 109-25 91-056 116-93 [95/8]		91-056 109-25 91-056 116-93 [95/8]	
Bandtrommel Tape reel Tambour-dérouleur Tambor-portacintas						91-056 758-70/895
Bandrollenträger Tape reel bracket Plateau dérouleur Portarrollos			91-043 942-70/895		91-043 942-70/895	

Table des sous-classes
 Tabla de subclases PFAFF 418

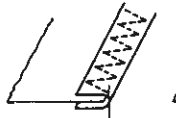
Unterklasse Subclass Sous-classe Subclase	-716/06-61/06 (-900/..)	-716/06-61/07 (-900/..)	-716/06-71/03 (-900/..)	-716/06-72/03 (-900/..)	-716/06-82/12 (-900/..)
Arbeitsgang Operation Opération Operación					
Ausführung Model Version Tipo de máquina	AN 2,5; BN 2,5	AN 2,5; BN 2,5	AN 2,5; BN 2,5	AN 2,5; BN 2,5	AN 2,5; BN 2,5
Übersichtsbreite in mm Stitch width in mm Jetée de l'aiguille en mm Anchura del zigzag en mm	10,0	10,0	10,0	10,0	10,0
Nadelstange Needle bar Barre à aiguille Barra de aguja	91-168 019-91	91-168 019-91	91-168 019-91	91-168 019-91	91-168 019-91
Stoffschieber ^[4] Feed dog Griffe Transportador inferior	91-047 645-04	91-047 645-04	91-047 365-04	91-047 645-04	91-047 857-04 ^[60] 91-059 467-04 ^[60]
Stichplatte ^[4] Needle plate Plaque à aiguille Placa de aguja	91-058 208-24	91-058 208-24	91-058 440-04	91-058 208-24	91-058 089-24
Nähfuß ^[4] Presser foot Pied presseur Pie prensatelas	91-055 369-93	91-055 366-93 ^[11/2]	91-055 704-03 ^[5] ^[11/2]	91-055 833-93	91-154 477-93 ^[15/1] ^[15] = 5,0 - 25,0 mm
Apparat ^[5] Attachment Appareil Aparato		91-053 958-23	91-056 082-23 91-056 086-93 91-056 090-25 91-056 091-23		91-050 716-93 ^[60/3] 91-461 720-93 ^[60/4]
Träger Bracket Support Soporte			91-056 116-93 ^[95/8]		91-156 634-90 ▲
Kopfplatte Face plate Plaque frontale Placa frontal			91-168 461-71/893		
Zwischenplatte Distance plate Plaque intermédiaire Placa intermedia			91-168 049-75/893		
Bandführung Tape guide Guide-ruban Guiacintas			91-053 228-91	91-042 036-91 91-050 926-21	
Bandtrommel Tape reel Tambour-dérouleur Tambor-portacintas	91-056 758-70/895	91-056 758-70/895	91-040 207-70/895 91-041 644-70/895		91-056 758-70/895
Platte und Feder Plate and spring Plaque et ressort Placa y muelle					91-170 363-15 91-170 364-15

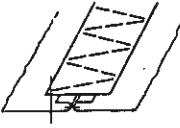
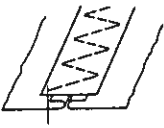
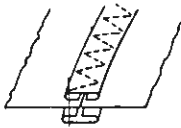
□ siehe Erläuterungen Register ^[A] ^[99]
 see explanations in section ^[A] ^[99]
 voir légende registre ^[A] ^[99]
 ver explicaciones del registro ^[A] ^[99]

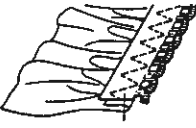
Table of subclasses
Table des sous-classes
Tabla de subclases PFAFF 418

Unterklasse Subclass Sous-classe Subclase	-716/06-82/13 (-900/..)	-716/06-83/03 (-900/..)	-718/01-6/01 (-900/..)	-718/01-6/01 -915/05(-900/..)	-748/26-17/98 -900/51-...
Arbeitsgang Operation Opération Operación			Zum Herstellen von Ziernähten. For making fancy seams. Coutures d'ornementation. Para costuras de adorno.	Zum Herstellen von Doppelziernähten bzw. Zweifarbzierenähten. For making twin fancy seams or two-colour fancy seams. Coutures d'ornementation à deux aiguilles ou à deux couleurs. Para costuras de adorno dobles o a dos colores.	
Ausführung Model Version Tipo de máquina	AN 2,5; BN 2,5	AN 2,5; BN 2,5	AN 2,5; BN 2,5	AN 2,5; BN 2,5	B
Nadelabstand in mm Needle gauge in mm Ecartement des aiguilles en mm Distancia entre agujas en mm				6,0	
Überschichtbreite in mm Stitch width in mm Jetée de l'aiguille en mm Anchura del zigzag en mm	10,0	10,0	10,0		6,0
Nadelstange Needle bar Barre à aiguille Barra de aguja	91-168 019-91	91-168 019-91	91-168 019-91	91-167 809-91	91-167 845-91
Stoffschieber ^[4] Feed dog Griffe Transportador inferior	91-047 857-04 ^[60] 91-059 467-04 ^[60]	91-047 857-04 ^[60] 91-059 467-04 ^[60]	91-047 646-04	91-047 646-04	91-047 343-04
Stichplatte ^[4] Needle plate Plaque à aiguille Placa de aguja	91-058 089-24	91-058 089-24	91-058 208-24	91-058 208-24	91-058 034-24
Nähfuß ^[4] Presser foot Pied presseur Pie prensatelas	91-154 477-93 ^[15/1] ^[15] = 5,0 - 25,0 mm	91-155 544-93 ^[112]	91-055 528-23	91-055 528-23	91-155 342-03
Apparat ^[5] Attachment Appareil Aparato	91-050 716-93	91-156 489-91			99-117 939-91
Träger Bracket Support Soporte	91-156 634-90				99-117 940-25
Kopfplatte Face plate Plaque frontale Placa frontal	91-168 461-71/893				
Zwischenplatte Distance plate Plaque intermédiaire Placa intermedia	91-168 049-75/893				
Bandführung Tape guide Guide-ruban Guiacintas	91-156 458-91	91-156 267-91			
Bandtrommel Tape reel Tambour-dérouleur Tambor-portacintas	91-056 758-70/895	91-156 255-71/895			
Bandrollenträger Tape reel bracket Plateau dérouleur Portarrollos					99-136 644-91
Platte und Feder Plate and spring Plaque et ressort Placa y muelle	91-170 363-15 91-170 364-15				

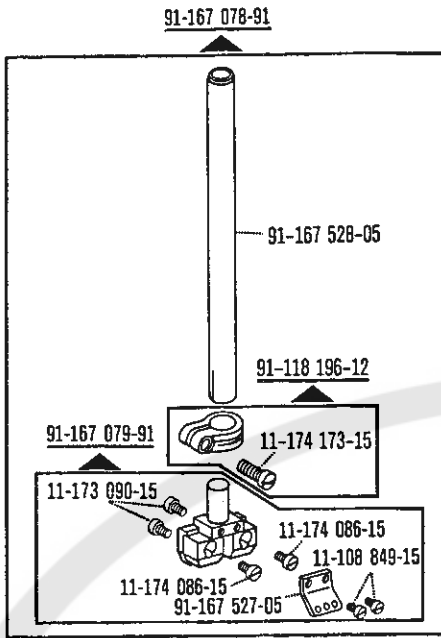

-49/01-915/02
 -61/08-915/02

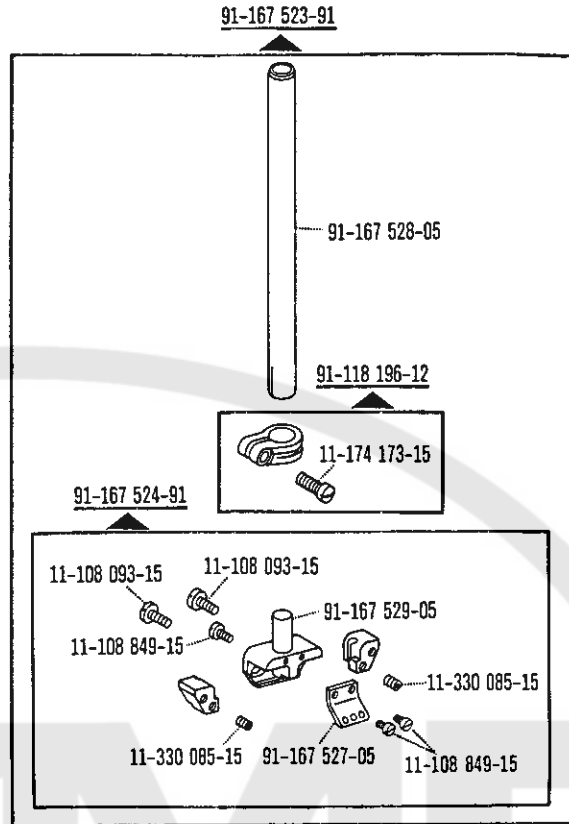

-45/22-915/23 (-900/..)

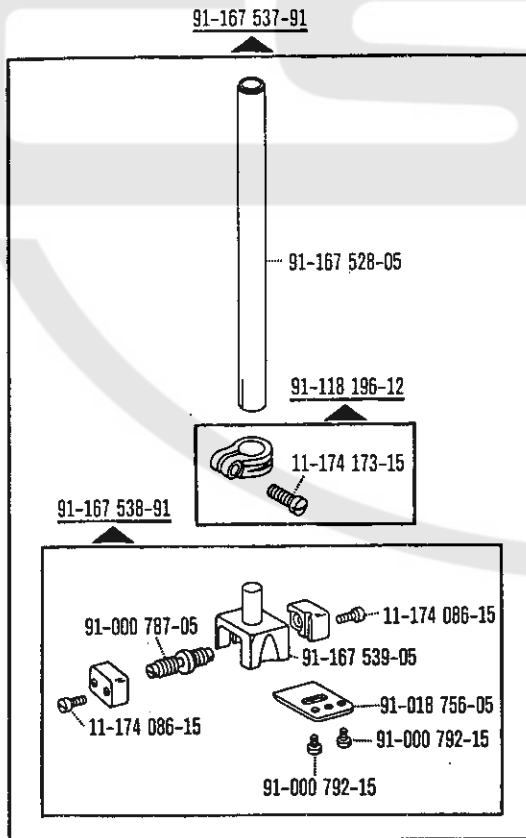



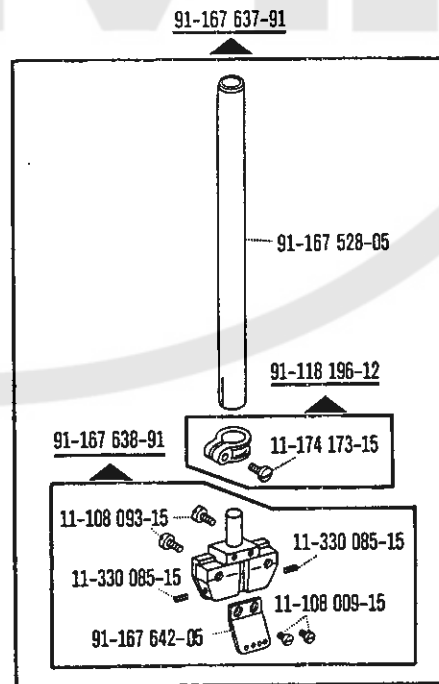





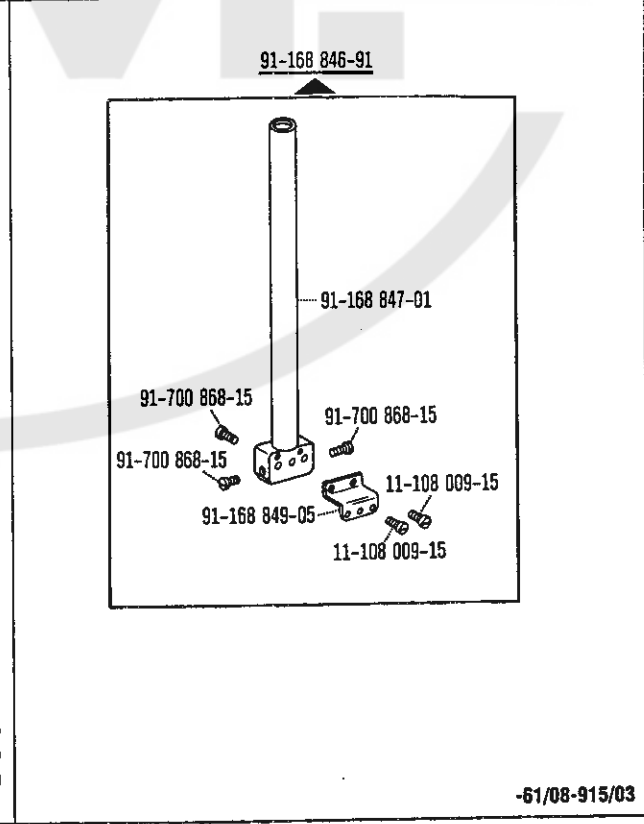
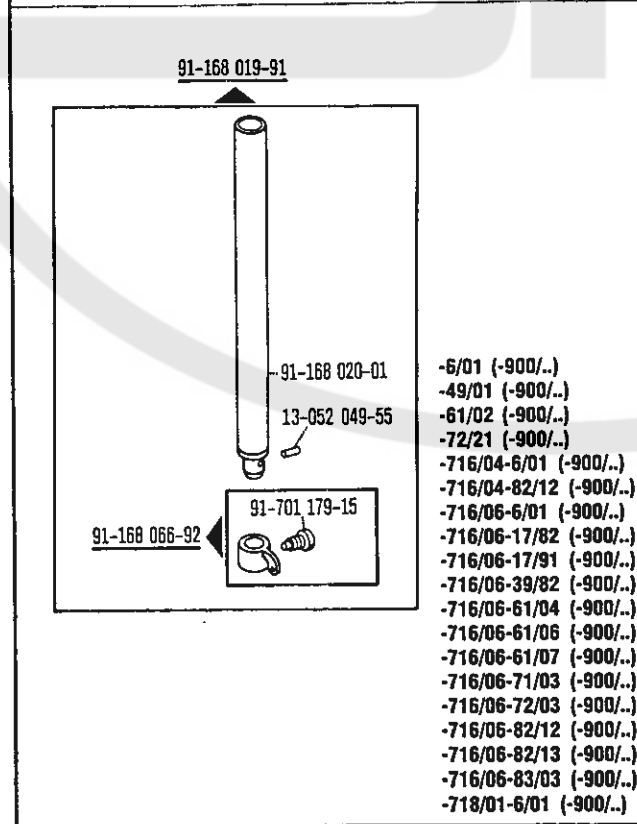
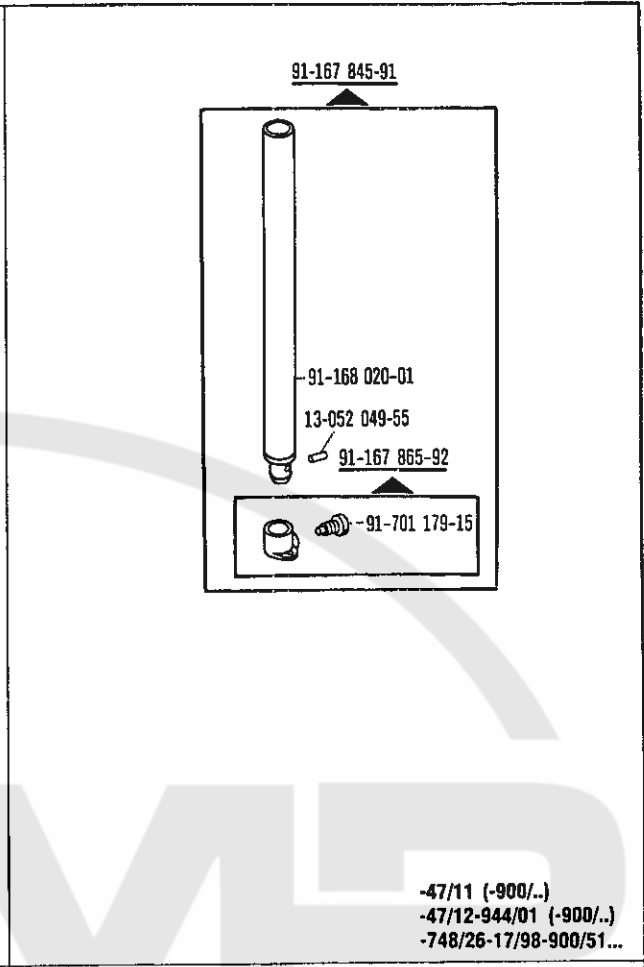
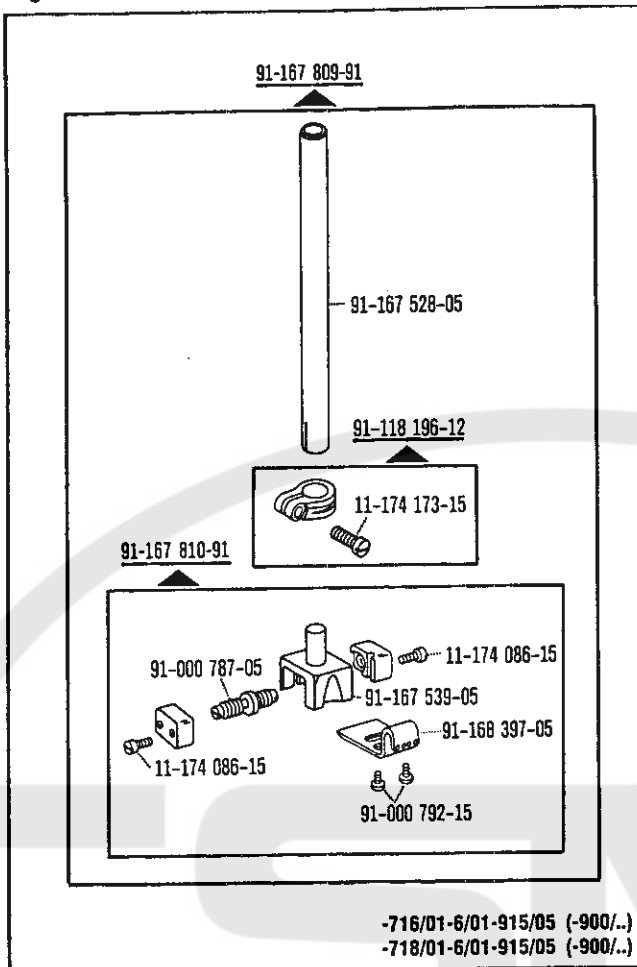



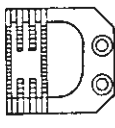

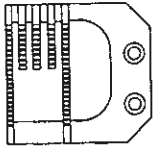

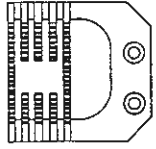

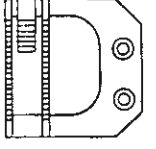

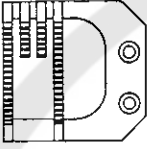

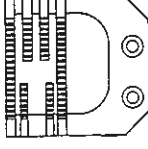

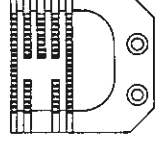

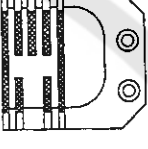

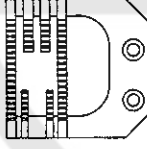

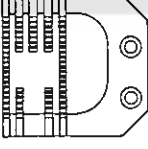

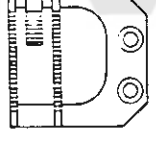
-45/11-915/05 (-900/..)
 -45/12-915/05 (-900/..)
 -55/10-915/05 (-900/..)

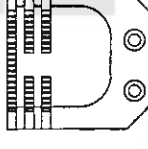

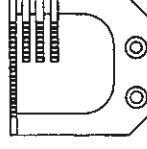

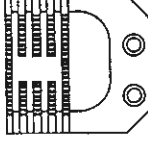

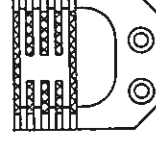

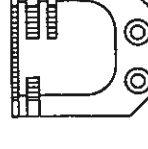

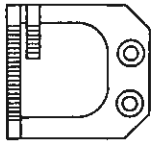

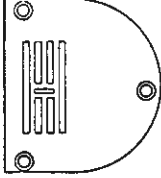

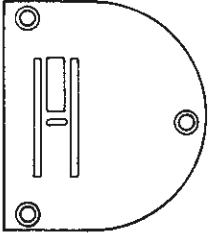

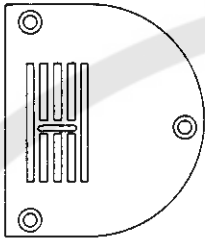

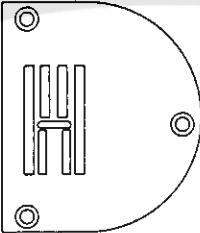

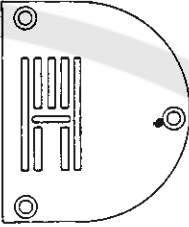

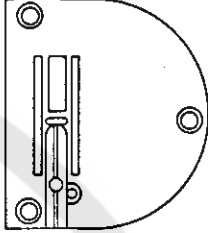

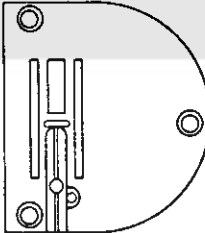

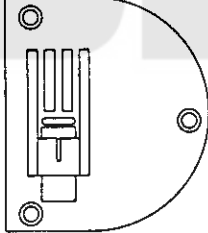

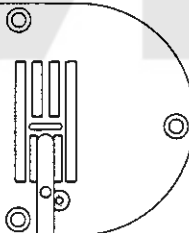

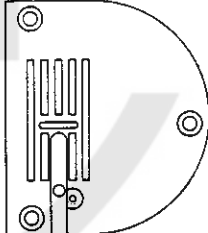

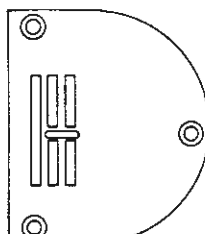

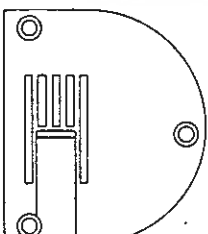

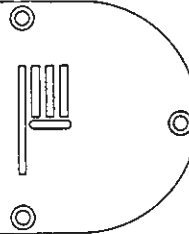
-45/12-915/04
 -61/01-915/04

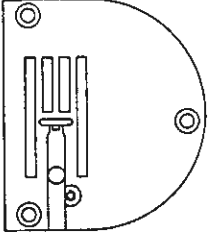
☐ siehe Erläuterungen Register [A] - [B]
 see explanations in section [A] - [B]
 voir légende registre [A] - [B]
 ver explicaciones del registro [A] - [B]

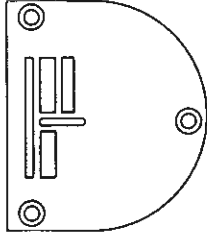
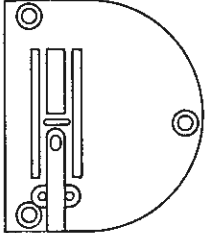
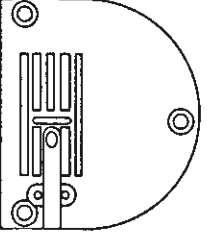
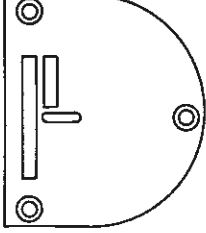

<p>91-047 343-04 </p>  <p>-748/26-17/98-900/51-...</p>	<p>91-047 365-04 </p>  <p>-716/06-71/03 (-900/..)</p>	<p>91-047 559-04 </p>  <p>-6/01 (-900/..) -61/01-915/04 -61/02 (-900/..)</p>	<p>91-047 570-04 </p>  <p>-45/11-915/05 (-900/..) -45/12-915/05 (-900/..) -55/10-915/05 (-900/..)</p>
<p>91-047 642-04 </p>  <p>-45/22-915/23 (-900/..) -72/21 (-900/..)</p>	<p>91-047 643-04 </p>  <p>-716/04-6/01 (-900/..) -716/04-82/12 (-900/..)</p>	<p>91-047 645-04 </p>  <p>-716/06-6/01 (-900/..) -716/06-6/01-915/05 (-900/..) -716/06-61/04 (-900/..) -716/06-61/06 (-900/..) -716/06-61/07 (-900/..) -716/06-72/03 (-900/..)</p>	<p>91-047 646-04 </p>  <p>-718/01-6/01 (-900/..) -718/01-6/01-915/05 (-900/..)</p>
<p>91-047 647-04 </p>  <p>-61/08-915/02</p>	<p>91-047 649-04 </p>  <p>-45/12-915/04 -49/01-915/02 -61/08-915/02 -61/08-915/03</p>	<p>91-047 678-04 </p>  <p>-45/11-915/05 (-900/..) -45/12-915/05 (-900/..) -45/12-915/05 B/CN</p>	<p>91-047 802-04 </p>  <p>-716/06-17/91 (-900/..)</p>
<p>91-047 827-04 </p>  <p>-716/06-17/82 (-900/..) -716/06-39/82 (-900/..)</p>	<p>91-047 857-04 </p>  <p>-716/06-82/12 (-900/..) -716/06-82/13 (-900/..) -716/06-83/03 (-900/..)</p>	<p>91-059 467-04 </p>  <p>-716/06-82/12 (-900/..) -716/06-82/13 (-900/..) -716/06-83/03 (-900/..)</p>	<p>91-059 565-04 </p>  <p>-47/11 (-900/..)</p>

<p>91-059 640-04 </p>  <p>-47/12-944/01 (-900/..)</p>		<p>91-058 034-24 </p>  <p>-748/26-17/98-900/51</p>	<p>91-058 086-24  </p>  <p>-55/10-915/05 (-900/..)</p>
<p>91-058 089-24 </p>  <p>-6/01 (-900/..) -61/01-915/04 -61/02 (-900/..) -716/06-82/12 (-900/..) -716/06-82/13 (-900/..) -716/06-83/03 (-900/..)</p>	<p>91-058 207-24 </p>  <p>-716/04-6/01 (-900/..) * -716/04-82/12 (-900/..)</p>	<p>91-058 208-24 </p>  <p>-716/06-6/01 (-900/..) -716/06-6/01-915/05 (-900/..) -716/06-61/04 (-900/..) -716/06-61/06 (-900/..) -716/06-61/07 (-900/..) -716/06-72/03 (-900/..) -718/01-6/01 (-900/..) -718/01-6/01-915/05 (-900/..)</p>	<p>91-058 253-04  </p>  <p>-45/11-915/05 (-900/..) -45/12-915/05 (-900/..)</p>
<p>91-058 254-04 </p>  <p>-45/11-915/05 (-900/..) -45/12-915/05 (-900/..)</p>	<p>91-058 374-03 </p>  <p>-72/21 (-900/..)</p>	<p>91-058 379-04 </p>  <p>-61/08-915/02</p>	<p>91-058 380-04 </p>  <p>-49/01 (-900/..) -49/01-915/02 -61/08-915/02 -61/08-915/03</p>
<p>91-058 386-24 </p>  <p>-716/06-17/91 (-900/..)</p>	<p>91-058 440-04 </p>  <p>-716/06-71/03 (-900/..)</p>	<p>91-058 442-04 </p>  <p>-716/06-17/82 (-900/..) -716/06-39/82 (-900/..)</p>	<p>91-058 673-04 </p>  <p>-45/22-915/23 (-900/..)</p>

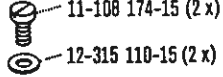
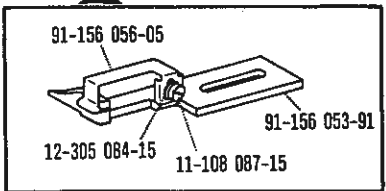
<p>91-058 832-24 A</p>  <p>-47/11 (-900/..)</p>	<p>91-058 844-04 A</p>  <p>-45/12-915/05</p>	<p>91-058 857-04 A</p>  <p>-45/12-915/04</p>	<p>91-158 430-24 A</p>  <p>-47/12-944/01 (-900/..)</p>
<p>91-026 900-14 202</p>  <p>91-100 265-15</p> <p>-45/11-915/05 (-900/..)</p>	<p>91-026 904-14 212</p>  <p>91-100 265-15</p> <p>-45/12-915/05 (-900/..)</p>	<p>91-048 103-05</p>  <p>91-100 265-15</p> <p>-61/08-915/02 -61/08-915/03</p>	<p>91-058 636-04 x 4,0 958</p>  <p>91-100 265-15</p> <p>-45/12-915/04 -45/12-915/05</p>
<p>91-058 674-05</p>  <p>91-100 265-15</p> <p>91-100 265-15</p> <p>-45/22-915/23 (-900/..)</p>	<p>91-158 185-15</p>  <p>91-100 265-15</p> <p>-49/01 (-900/..) -49/01-915/02</p>		
<div style="text-align: center;"> <p>91-156 052-91</p>  <p>11-108 174-15 (2 x) 12-315 110-15 (2 x)</p> <div style="border: 1px solid black; padding: 5px; width: fit-content; margin: 0 auto;">  <p>91-156 056-05 91-156 053-91 12-305 084-15 11-108 087-15</p> </div> <p>-47/12-944/01 (-900/..)</p> </div>			



□ siehe Erläuterungen Register A - 20
 see explanations in section A - 20
 voir légende registre A - 20
 ver explicaciones del registro A - 20

Gauge parts
 Organes de couture
 Organos de costura PFAFF 418

<p>91-055 106-23 ⁽⁴⁾ ^(17/2)</p>  <p>-6/01 (-900/..) -61/02 (-900/..) -716/04-6/01 (-900/..) -716/06-6/01 (-900/..)</p>	<p>91-055 366-93 ⁽⁴⁾ ^(17/2)</p>  <p>-716/04-82/12 (-900/..) -716/06-61/07 (-900/..)</p>	<p>91-055 369-93 ⁽⁴⁾</p>  <p>-716/06-61/06 (-900/..)</p>	<p>91-055 524-93 ⁽⁴⁾</p>  <p>-716/06-61/04 (-900/..)</p>
<p>91-055 528-23 ⁽⁴⁾</p>  <p>-718/01-6/01 (-900/..) -718/01-6/01-915/05 (-900/..)</p>	<p>91-055 530-03 ⁽⁴⁾</p>  <p>-49/01 (-900/..) -49/01-915/02 -72/21 (-900/..)</p>	<p>91-055 544-23 ⁽⁴⁾</p>  <p>-716/06-17/91 (-900/..)</p>	<p>91-055 524-93 ⁽⁴⁾ ^(10/2) ^(15/1) ⁽¹⁵⁾ = 9,0 - 14,0 mm</p>   <p>91-154 399-05 ^(15/1) ⁽²⁸⁾ ⁽¹⁵⁾ = 5,0 - 10,0 mm 91-154 398-05 ^(15/1) ⁽²⁸⁾ ⁽¹⁵⁾ = 5,0 - 10,0 mm -61/08-915/02</p>
<p>91-055 704-03 ⁽⁴⁾ ⁽³⁾ ^(17/2)</p>  <p>-716/06-71/03 (-900/..)</p>	<p>91-055 708-93 ⁽⁴⁾</p>  <p>-716/06-17/82 (-900/..) -716/06-39/82 (-900/..)</p>	<p>91-055 726-23 ⁽⁴⁾</p>  <p>-716/06-6/01-915/05 (-900/..)</p>	<p>91-055 818-03 ⁽⁴⁾ ^(10/2) ^(15/1) ⁽¹⁵⁾ = 12,0 - 15,0 mm</p>  <p>-61/08-915/03</p>
<p>91-055 833-93 ⁽⁴⁾</p>  <p>-716/06-72/03 (-900/..)</p>	<p>91-057 006-93 ⁽⁴⁾</p>  <p>-45/22-915/23 (-900/..)</p>	<p>91-057 007-93 ⁽⁴⁾</p>  <p>-45/12-915/04 -45/12-915/05</p>	

<p>91-057 012-93 4 10 2</p>  <p>-45/11-915/05 (-900/..) -45/12-915/05 (-900/..) -55/10-915/05 (-900/..)</p>	<p>91-057 408-93 4</p>  <p>-47/11 (-900/..)</p>	<p>91-154 023-03 4 15 1 15 = 12,0 - 15,0 mm</p>  <p>-61/01-915/04</p>	<p>91-154 477-93 4 15 1 15 = 5,0 - 25,0 mm</p>  <p>-716/06-82/12 (-900/..) -716/06-82/13 (-900/..)</p>
<p>91-155 342-03 4</p>  <p>-748/26-17/98-900/51-...</p>	<p>91-155 544-93 4 11 2</p>  <p>-716/06-83/03 (-900/..)</p>	<p>91-157 928-93 4</p>  <p>-47/12-944/01 (-900/..)</p>	
<p>91-050 648-25</p>  <p>-716/06-61/04 (-900/..)</p>	<p>91-700 112-25</p>  <p>-47/11 (-900/..)</p>	<p>91-056 104-91</p>  <p>-716/06-6/01-915/05 (-900/..)</p>	<p>91-156 186-15</p>  <p>-47/12-944/01 (-900/..)</p>
<p>91-000 262-25</p> <p>91-025 559-25</p>  <p>-716/06-17/91 (-900/..) -716/06-61/04 (-900/..)</p>	<p>91-055 555-05</p>  <p>-61/01-915/04 -61/08-915/02 -61/08-915/03</p>	<p>91-057 193-04 19 2</p> <p>11-108 174-15</p>  <p>-45/12-915/04 -45/12-915/05</p>	<p>91-129 955-25</p> <p>12-305 144-15</p> <p>11-460 250-15</p>  <p>-45/12-915/04 -45/12-915/05 -45/22-915/23</p>

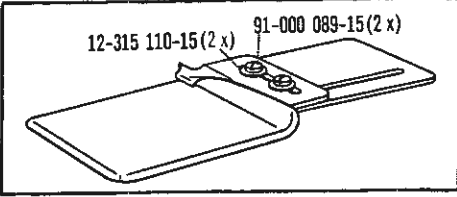
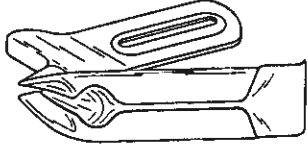
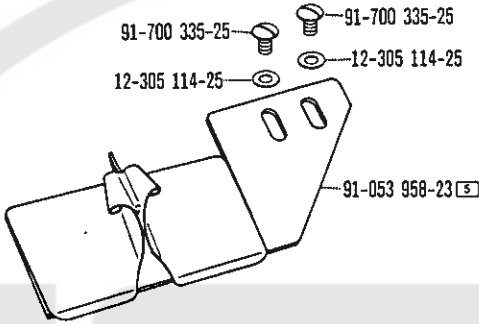
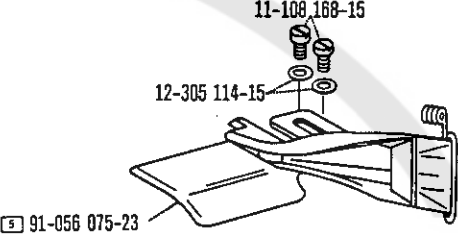
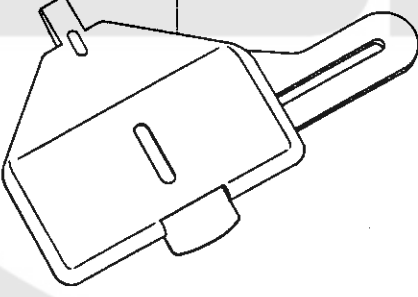
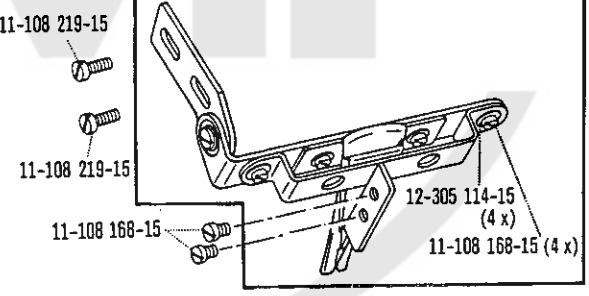
☐ siehe Erläuterungen Register 4 10
see explanations in section 4 10
voir légende registre 4 10
ver explicaciones del registro 4 10

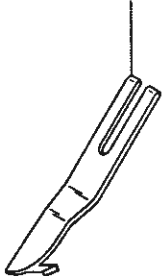
 <p>91-050 716-93</p> <p>12-315 110-15 (2x) 91-000 089-15 (2x)</p> <p>-716/04-82/12 (-900/..) -716/06-82/12 (-900/..) -716/06-82/13 (-900/..)</p>	 <p>91-050 959-93</p> <p>-716/06-17/91 (-900/..)</p>
 <p>91-700 335-25 91-700 335-25 12-305 114-25 12-305 114-25</p> <p>91-053 958-23</p> <p>-716/06-61/07 (-900/..)</p>	 <p>11-108 168-15</p> <p>12-305 114-15</p> <p>91-056 075-23</p> <p>-716/06-39/82 (-900/..)</p>
 <p>91-056 082-23</p> <p>-716/06-71/03 (-900/..)</p>	 <p>91-056 086-93</p> <p>11-108 219-15 11-108 219-15 11-108 168-15 11-108 168-15 (4x) 12-305 114-15 (4x)</p> <p>-716/06-71/03 (-900/..)</p>
 <p>91-056 090-25</p> <p>-716/06-71/03 (-900/..)</p>	 <p>91-056 091-23</p> <p>-716/06-71/03 (-900/..)</p>

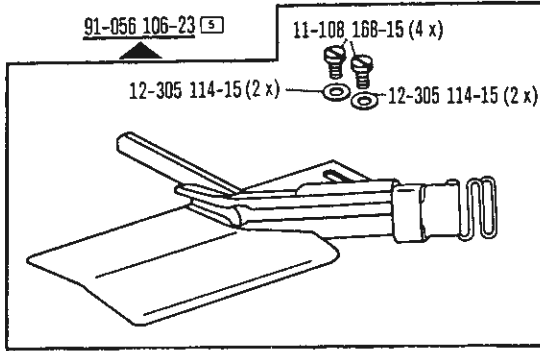

-716/06-17/82 (-900/..)

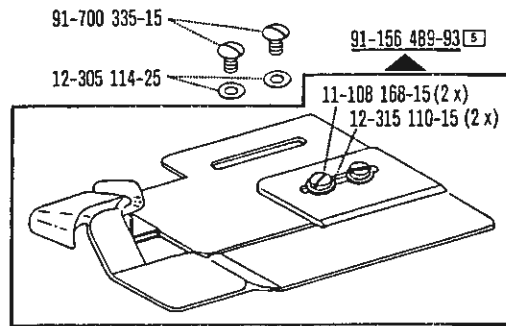

-716/06-83/03 (-900/..)

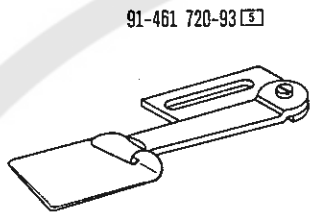

-716/06-82/12 (-900/..)

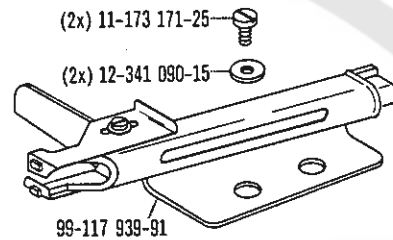

-748/26-17/98-900/51

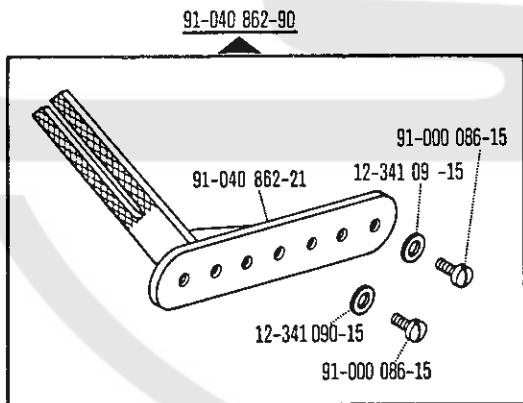

-61/02 (-900/..)

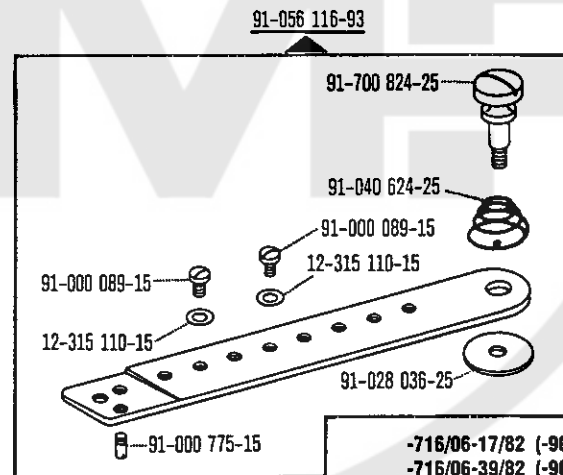

-716/06-17/82 (-900/..)
 -716/06-39/82 (-900/..)
 -716/06-71/03 (-900/..)

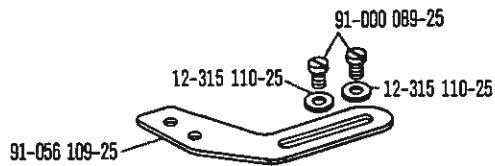

-716/06-17/82 (-900/..)
 -716/06-39/82 (-900/..)

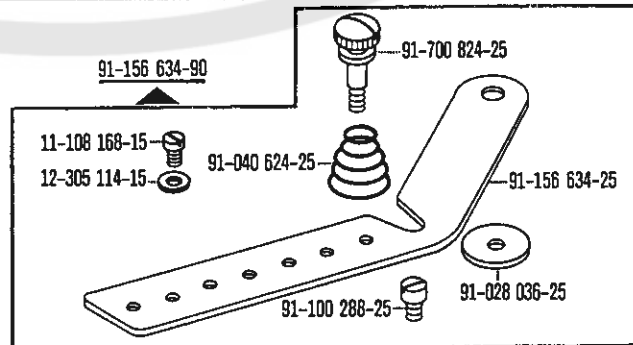

-716/04-82/12 (-900/..)
 -716/06-82/12 (-900/..)
 -716/06-82/13 (-900/..)

Gauge parts
 Organes de couture
 Organos de costura PFAFF 418

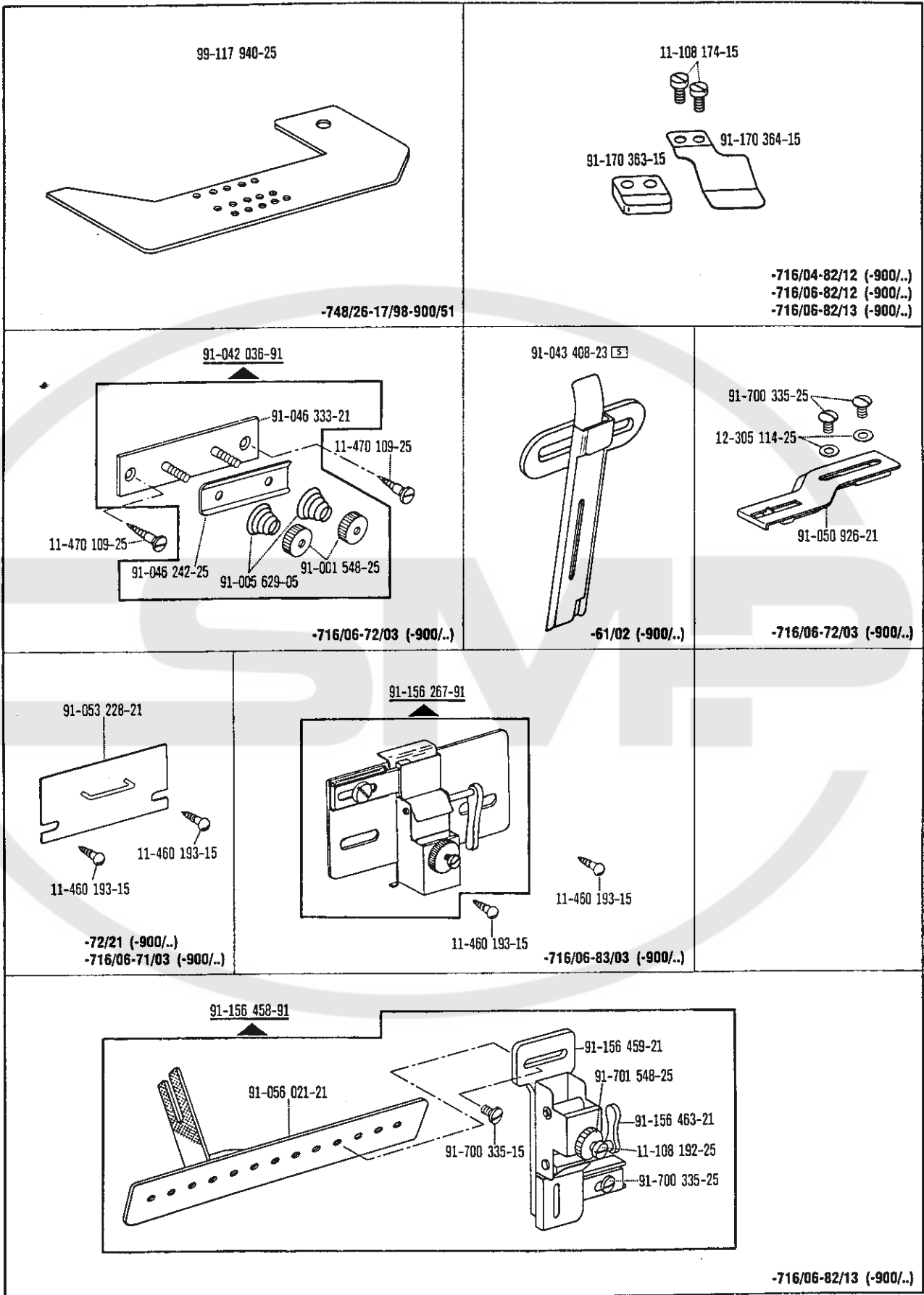

91-040 207-70/895

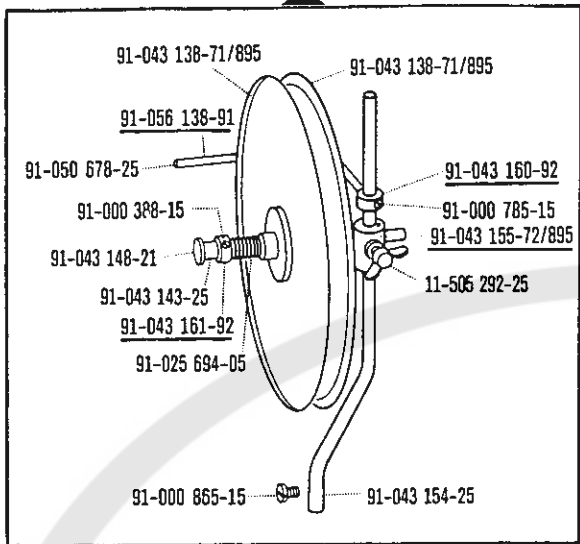

-716/06-71/03 (-900/..)

91-041 644-70/895

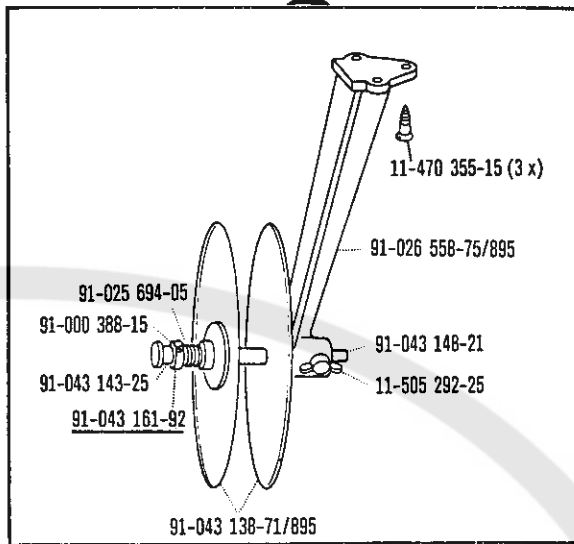

-72/21 (-900/..)
-716/06-71/03 (-900/..)

91-043 938-70/895

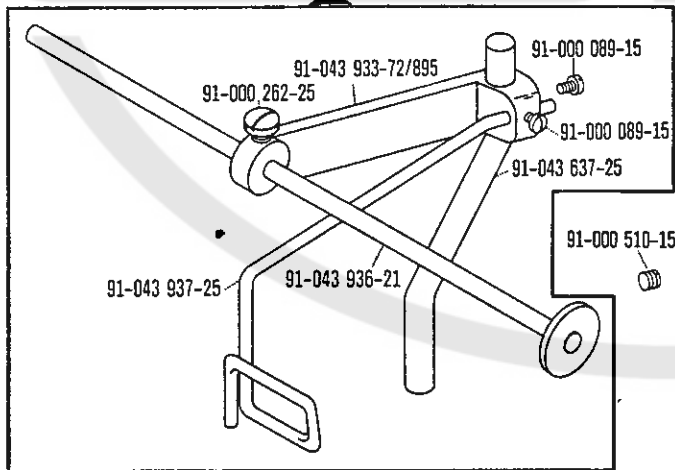

-61/08-915/02
-61/08-915/03

91-043 942-70/895

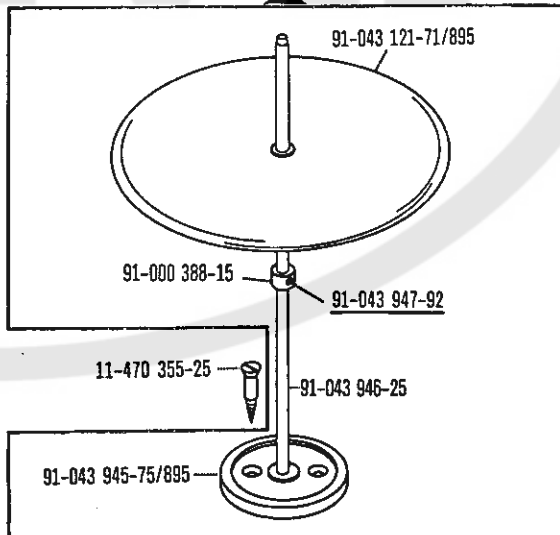

-716/06-17/82 (-900/..)
-716/06-39/82 (-900/..)

